

HYDRAULIC POWER ACCESSORIES



SYSTEM COMPONENTS

Electric Motors: 143TC thru 405TC

Visit www.hyvair.com Fluid Power Data for performance data and dimensional information.
(56 frame steel construction & single phase motors also listed)

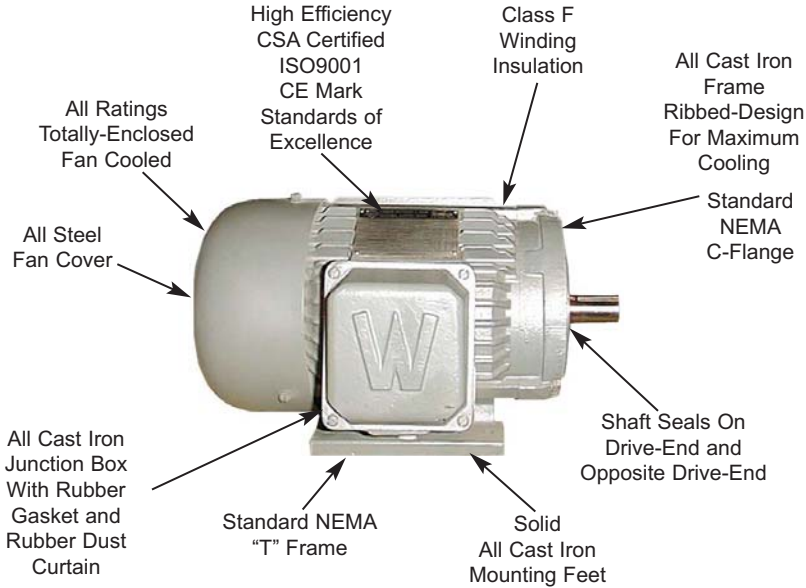

Motor HP	WW Series 1200 RPM	Standard WW Series 1800 RPM	WW Series 3600 RPM
1	WW1-12-145TC	WW1-143TC	
1.5	WW1.5-12-182TC	WW1.5-145TC	WW1.5-3C6-145TC
2	WW2-12-184TC	WW2-145TC	WW2-36-145TC
3	WW3-12-213TC	WW3-182TC	WW3-36-182TC
5	WW5-12-215TC	WW5-184TC	WW5-36-184TC
7.5	WW7.5-12-254TC	WW7.5-213TC	WW7.5-36-213TC
10	WW10-12-256TC	WW10-215TC	WW10-36-215TC
15	WW15-12-284TC	WW15-254TC	WW15-36-254TC
20	WW20-12-286TC	WW20-256TC	WW20-36-256TC
25	WW25-12-324TC	WW25-284TC	WW25-36-284TSC
30	WW30-12-326TC	WW30-286TC	WW30-36-286TSC
40	WW40-12-364TC	WW40-324TC	WW40-36-324TSC
50	WW50-12-365TC	WW50-326TC	WW50-36-326TSC
60	WW60-12-404TC	WW60-364TC	WW60-36-364TSC
75	WW75-12-405TC	WW75-365TC	WW75-36-365TSC
100	WW100-12-444TC	WW100-405TC	WW100-36-405TSC

Note: Motors are shipped with anti-rotation lock on output shaft to prevent damage during shipment. Remove lock before starting.
(Not generally used for continuous duty hyd. pumps)

Pump/ Motor Adapters: 56TC thru 405TC

Visit www.hyvair.com Fluid Power Data for available models and dimensional information.

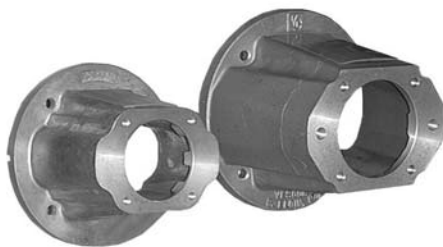

Couplings- Jaw Type
Visit www.hyvair.com Fluid Power Data for available models and dimensional information.

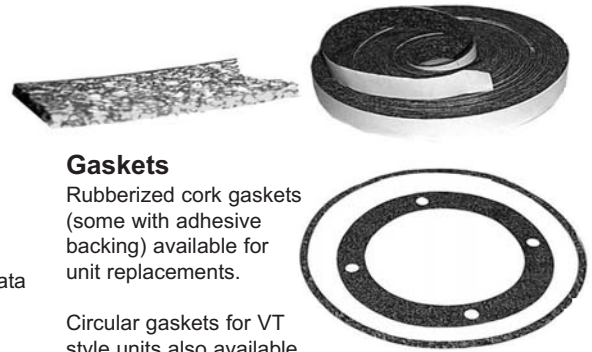

Gaskets
Rubberized cork gaskets (some with adhesive backing) available for unit replacements.

Circular gaskets for VT style units also available.

Suction Strainers: 3/8" thru 3"



A, Size Female NPT	Part Number	B	C
3/8	FO-08989	2-1/4	2-11/16
1/2	FO-08995	2-1/4	2-11/16
3/4	FO-09005	3-3/16	3-1/2
1	FO-09010	3-3/16	5-3/4
1-1/4	FO-09020	3-3/16	7-3/8
1-1/2	FO-10035	4-3/16	9-1/8
2	FO-00935	4-3/16	9-1/8
2-1/2	FO10060	5-1/16	12-1/2

Units: inches

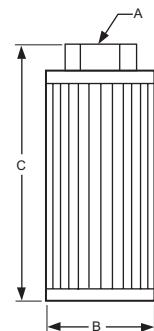

HYDRAULIC POWER ACCESSORIES **HYVAIR**[®]

SYSTEM COMPONENTS



HYV-1
Return filter gauge
For ITF and Canister Filters
0-25 psi green/ 26-50 psi red,
1/8" npt center back mount



TA46F
Small Filler/ Breather
1.61" Bolt Circle
10 micron breather



FB-12S (standard)
Filler/ Breather
2.87" Bolt Circle
Plastic ABS version avail.



SLG5 (standard)
5" Sight Gauge w/ Dual Scale
Thermometer 0°F to 220°F &
-20°C to 110°C

Aluminum/ Glass Construction
(no fading plastic used)



SLG3 (VTB & VTD18)
shown right, 3" centerline
between bolts- plastic lens,
aluminum shell

Temp Switch

Normally Closed SPST:
T22-4-(temp)°F
120°, 140°, 150° Avail.
230 vac max.
6 amps max.

Normally Open SPST:
T23-4-(temp)°F
121°, 141°, 151° Avail.
230 VAC max.
4 amps max.



8" insertion depth
(flange= 3 equally spaced 0.15"
dia. holes on 2.87" bolt circle)

Float Switch

L180001
10 VA SPST
0.1 amps @120 VAC
0.25 amps @24 VDC

220° F max.
8" insertion depth
(flange= 3 equally spaced 0.15"
dia. holes on 2.87" bolt circle)

6" actuation point (low mark on
sight gauge)

(supplied N.O. with dry tank;
float may be flipped 180° to
modify for N.C.)



Heater 1.5kW

BGS713J7S
230/460VAC 1 phase, 0-110°F Thermostat w/ light
2" male NPT connection, 14" insertion length,
1/2" conduit knock-out, 5-1/2" dia. shell x
6-1/4" exterior length

Series B, brass ball valve designed for air, oil, and water.
Pressure Ratings:

1/4" thru 2": 600 psi @100°F, 100 psi @375°F
2 1/2" thru 4": 400 psi @100°F, 100 psi @200°F

Materials:

Body/ End Cap- Brass, forged
Ball- Chrome plated brass
Nut, Stem, Pkg. Nut- Brass
Ball Seats, Thrust Washer, Stem Seal- Reinforced PTFE
Handle- Steel dactromet finish w/ vinyl grip
Option "L" for Locking handle



B-BV-✱FP

B-BV-8FP-8MP

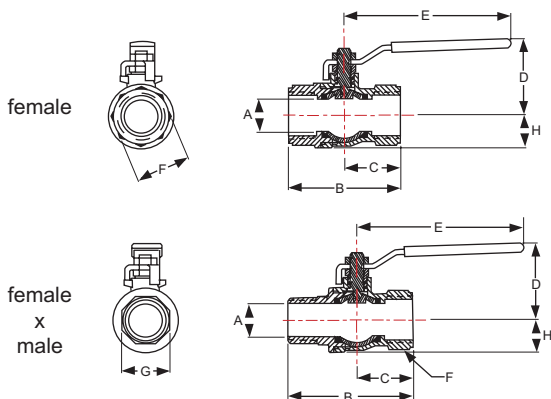

SIZE (npt)	MODEL	Dimensions			
		A	B	D	E
1/4" female	B-BV-4FP	0.375	1.75	1.44	3.75
1/4" female x male	B-BV-4FP-4MP	0.32	2.17	1.56	3.23
3/8" female	B-BV-6FP	0.375	1.75	1.50	3.75
3/8" female x male	B-BV-6FP-6MP	0.38	2.17	1.56	3.23
1/2" female	B-BV-8FP	0.5625	2.0	1.875	3.625
1/2" female x male	B-BV-8FP-8MP	0.59	2.66	1.73	3.94
3/4" female	B-BV-12FP	0.75	2.25	2.125	4.375
3/4" female x male	B-BV-12FP-12MP	0.75	2.91	1.97	4.72
1" female	B-BV-16FP	0.9375	2.75	2.25	4.75
1" female x male	B-BV-16FP-16MP	0.95	3.56	2.13	4.72
1-1/4" female	B-BV-20FP	1.25	3.25	2.75	5.1875
1-1/2" female	B-BV-24FP	1.50	3.50	3.0	5.625
2" female	B-BV-32FP	2.0	4.1875	3.5	6.0
2-1/2" female	B-BV-40FP	2.375	5.5	5.0	9.0
3" female	B-BV-48FP	3.0625	6.25	5.375	9.0
4" female	B-BV-64FP	3.9063	7.5	6.0	10.0

Units: inches



HYDRAULIC POWER ACCESSORIES **HYVAIR**[®]

PRESSURE GAUGES

General Hydraulic Service

Stainless Steel Case, Brass Internals, Glycerin-Filled, 1/8" 1/4" & 1/2" NPT Ports, Vacuum to 15,000 PSI



BM- Bottom Ports
Crimped Case- Standard



TB- Twist on Bezel
(Optional)



LB- Lower Back Ports
U- Mounting Clamp



CB- Center Back Ports
P- Panel Mounting



W- Wall Mounting
TB- Twist on Bezel

Brass Pressure Snubber:

1/4" Female NPT
x 1/4" Male NPT

Model Number
602



Model 602: we recommend the "green striped" element (porosity 20) for most hydraulic applications.

316SS Pressure Snubber:

1/4" Female NPT
x #4" Male SAE

Model Number:
D-SN1-4FP-4MS



Steel Pressure Snubber:

1/4" Female NPT
x #6" Male SAE

Model Number:
S-SN1-4FP-6MS



Gauge Isolator:

Isolates and holds gauge's last pressure- no drain
#6 SAE 1/4" NPT

Model Number	Model Number
G11-6FS	G11-4FP

Ordering Information

HYV- 2K - 2.5 - 4 - U - CB - O - Option Code/s - (Omit if None)

Pressure Range- Zero to: (psig)				Gauge Size- Dia.	Port Size	Mounting	Port Location	Series
-30 Vac	160	800	6k	1.5	2- 1/8" MP	N- None	BM- Bottom	O- Hyd. Service; Glyc. Filled, 304SS Case, Brass Internals
15	200	1k	10k	2	4- 1/4" MP	P- Panel	CB- Center/ Back	U- Air Service; Dry, Non-Filled, Steel Case, Brass Internals
30	300	1.5k	15k	2.5	8- 1/2" MP	U- U-Clamp	LB- Lower/ Back	M- Mfg Code- must be in place to continue options
60	400	2k	20k	4	4F- 1/8" MP	W- Wall		H- same as series U but with black face & Hyvair logo
100	500	3k	25k	6	4MS- 4MS			
	600	4k	30k		4A- 9/16-18 Aminco			
		5k	35k		6A- 3/4-16 Aminco			
Available Dry or Filled		Available Filled Only		<p>Example: 0-2000 psig, 2.5" Dia., 1/4" Male NPT, U- Clamp Mounting, Center Back Ports, OEM Series- Glycerin Filled</p>				

Case	Internals	Fill Fluid	Options (Listed Alphabetically)	
B- Brass	B- Brass	D- Dry	A- Adapter Ring 4-1/2"	MP- Max Press. Pointer
C- 304SS	C- 304SS	F- Fillable	B- Bar/ Psi	P- Plastic Lens
D- 316SS	D- 316SS	G- Glycerin	C- Calibrated	R- Red Stationary Pointers
P- Polyamid	M- Monel	S- Silicon	G- Glass Lens	RS- Restrictor Screw
S- Steel	S- Steel		K- kPa/ Psi	SB- Solid Front/ Blow-Out Back
			K2- kg/sq-cm	T- High Temp Service
			MD- Mirror Dial w/ Knife Edge Pointer	Z- Special/ Write Out
			MM- Min/ Max Pointers	



HYDRAULIC POWER ACCESSORIES **HYVAIR**[®]

QUICK DISCONNECTS- TWO WAY

Interchanges with S600, AN Series

ISO A:
1/4" thru 1", Steel Only

PRESSURE RATINGS

SERIES	PSI	BAR
4FP	4,600	315
6FP	3,000	207
8FP	3,600	248
12FP	4,000	275
16FP	3,000	207

FLOW CAPACITY

SERIES	Cv	Ac
4FP	0.8	19
6FP	1.8	46
8FP	3.2	80
12FP	5.9	148
16FP	9.7	242

SIZE SOCKETS

1/4" FPT	QD-2WA-4FP-4S
3/8" FPT	QD-2WA-6FP-6S
1/2" FPT	QD-2WA-8FP-8S
3/4" FPT	QD-2WA-12FP-12S
1" FPT	QD-2WA-16FP-16S

SIZE PLUGS

1/4" FPT	QD-2WA-4FP-4P
3/8" FPT	QD-2WA-6FP-6P
1/2" FPT	QD-2WA-8FP-8P
3/4" FPT	QD-2WA-12FP-12P
1" FPT	QD-2WA-16FP-16P

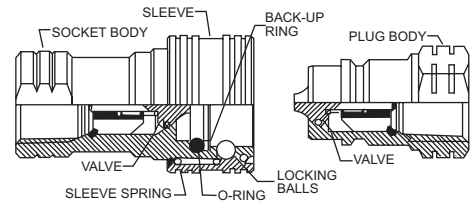

The hyair series A conforms to the dimensional requirements of the ISO Standard 7241-I Series A. All pressure ratings maintain a 4:1 safety factor

This series available steel only at this time.
(No material prefix required)

SIZE	SOCKET	DIMENSIONS			SIZE	PLUG	DIMENSIONS		
		A	B	C			D	E	F
1/4" FPT	QD-2WA-4FP-S	1.89	1.07	0.88	1/4" FPT	QD-2WA-4FP-4P	1.40	0.86	0.75
3/8" FPT	QD-2WA-6FP-S	2.22	1.27	1.00	3/8" FPT	QD-2WA-6FP-6P	1.68	1.00	0.88
1/2" FPT	QD-2WA-8FP-S	2.62	1.50	1.31	1/2" FPT	QD-2WA-8FP-8P	1.95	1.22	1.06
3/4" FPT	QD-2WA-12FP-S	3.24	1.88	1.56	3/4" FPT	QD-2WA-12FP-12P	2.39	1.52	1.31
1" FPT	QD-2WA-16FP-S	3.89	2.11	1.88	1" FPT	QD-2WA-16FP-16P	2.83	1.79	1.62

Interchanges with FP45, HN Series

ISO B:
1/4" thru 2" (1/4" thru 1" shown),
Steel, Brass, Stainless

PRESSURE RATINGS

SIZE	"S" STEEL STANDARD SERVICE		"B" BRASS SERVICE		"C"= 303SS "D"= 316SS	
	PSI	BAR	PSI	BAR	PSI	BAR
4FP	3,700	255	2,700	186	3,700	255
6FP	3,700	255	2,200	152	3,700	255
8FP	5,000	345	2,250	155	4,250	293
12FP	4,000	275	2,000	138	3,500	242
16FP	4,000	275	1,500	103	2,500	173

FLOW CAPACITY

SIZE	Cv	Cv LESS VALVES	
		W/VALVE	ACTUATOR
4FP	1.1	2.2	1.0
6FP	1.9	4.0	1.8
8FP	3.2	7.6	3.1
12FP	7.2	21.0	7.2
16FP	10.3	36.0	10.4

SIZE STEEL SOCKETS

1/4" FPT	SQD-2WB-4FP-4S
3/8" FPT	SQD-2WB-6FP-6S
1/2" FPT	SQD-2WB-8FP-8S
3/4" FPT	SQD-2WB-12FP-12S
1" FPT	SQD-2WB-16FP-16S

SIZE STEEL PLUGS

1/4" FPT	SQD-2WB-4FP-4P
3/8" FPT	SQD-2WB-6FP-6P
1/2" FPT	SQD-2WB-8FP-8P
3/4" FPT	SQD-2WB-12FP-12P
1" FPT	SQD-2WB-16FP-16P

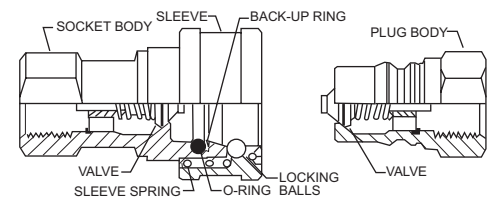

The hyair series B conforms to ISO 7241-1 series B standard. All pressure ratings maintain a 4:1 safety factor

Specify material prefix when ordering:
S= Steel, B= Brass, C= 303SS, D= 316SS

SIZE	SOCKET	DIMENSIONS			SIZE	PLUG	DIMENSIONS		
		A	B	C			D	E	F
1/4" FPT	QD-2WB-4FP-4S	2.26	1.17	0.88	1/4" FPT	QD-2WB-4FP-4P	1.52	0.87	0.75
3/8" FPT	QD-2WB-6FP-6S	2.56	1.42	1.00	3/8" FPT	QD-2WB-6FP-6P	1.76	1.01	0.88
1/2" FPT	QD-2WB-8FP-8S	2.96	1.86	1.28	1/2" FPT	QD-2WB-8FP-8P	2.03	1.30	1.13
3/4" FPT	QD-2WB-12FP-12S	3.48	2.22	1.56	3/4" FPT	QD-2WB-12FP-12P	2.36	1.52	1.31
1" FPT	QD-2WB-16FP-16S	4.13	2.61	1.86	1" FPT	QD-2WB-16FP-16P	2.85	1.88	1.63

